

<b>Electrical Characteristics</b>										
Frequency	Hz	50				60				
Voltage (parallel star)	V	380	400	415	440	415	440	460	480	
Rated power class H	kVA	1100	1100	1100	1000	1200	1260	1320	1320	
	kW	880	880	880	800	910	1008	1056	1056	
Rated power class F	kVA	1000	1000	1000	910	1090	1145	1200	1200	
	kW	800	800	800	728	872	916	960	960	
Regulation with	DSR	±1% with any power factor and speed variations between -5% +30%								
Insulation class		H								
Execution		Brushless								
Stator winding		12 ends								
Rotor		with damping cage								
Efficiencies class H	4/4	%	95,9	95,8	95,6	95,4	95,6	96,1	96,3	96
(see graph. for details)	3/4	%	96,3	96	96,1	95,9	95,8	96,1	96,3	96,1
	2/4	%	94,9	94,8	94,9	94,5	94,9	95	95,2	95,1
	1/4	%	92	92	91,8	91,3	93	93	93	93
<b>Reactances (f. l.c.l. F)</b>										
	Xd	%	387,8	350	325,2	263,2	425,3	397,4	381,1	350
	Xd'	%	21,7	19,6	18,2	14,7	23,8	22,3	21,34	19,6
	Xd''	%	11,2	10,1	9,4	7,6	12,3	11,5	11	10,1
	Xq	%	164	148	137,5	111,3	179,8	168,1	161,1	148
	Xq'	%	164	148	137,5	111,3	179,8	168,1	161,1	148
	Xq''	%	21,7	19,6	18,2	14,7	23,8	22,3	21,3	19,6
	X <sub>2</sub>	%	16,4	14,8	13,7	11,1	18	16,8	16,11	14,8
	X <sub>0</sub>	%	3,9	3,5	3,3	2,6	4,3	4,0	3,81	3,5
Short Circuit Ratio	Kcc		0,30	0,35	0,40	0,50	0,21	0,25	0,30	0,35
Time Constants	Td'	sec.	0,245							
	Td''	sec.	0,0176							
	Tdo'	sec.	8,10							
	Tα	sec.	0,0235							
Short Circuit Current Capacity		%	>300				>350			
Excitation at no load	Amp.		0,4	0,5	0,6	0,8	0,3	0,4	0,5	0,5
Excitation at full load	Amp.		2,5	2,8	2,9	3,1	2,3	2,4	2,5	2,8
Overload (long-term)		%	1 hour in a 6 hours period 110% rated load							
Overload per 20 sec.		%	300							
Stator Winding Resistance (20°C)	Ω		0,0078							
Rotor Winding Resistance (20°C)	Ω		2,500							
Exciter Resistance (20 °C)	Ω		Rotor : 0,130				Stator : 10,63			
Heat dissipation at f.l.c.l.H	W		37623	38580	40502	38574	41883	40907	40573	44000
Telephone Interference			THF < 2%				TIF < 40			
Radio interference			EN61000-6-3, EN61000-6-1. For others standards apply to factory							
Waveform Distors.(THD) at f. load	LL/LN %		1,5 / 1,7							
Waveform Distors.(THD) at no load	LL/LN %		2,1 / 2,1							
<b>Mechanical characteristics</b>										
Protection			IP 21 (other protection on request)							
DE bearing			6324							
NDE bearing			6322							
Weight of wound stator assembly	kg		861							
Weight of wound rotor assembly	kg		642							
Weight of complete generator	kg		2395							
Maximun overspeed	rpm		2250							
Unbalanced magnetic pull at f.l.c.l.F	kN/mm		5							
Cooling air requirement	m <sup>3</sup> /min		90				108			
Inertia Constant (H)	sec.		0,247				0,297			
Noise level at 1m/7m	dB(A)		95 / 84				99 / 89			

All technical data are to be considered as a reference and they can be modified without any notice.

This document is a propriety of Mecc Alte S.p.A.. All rights reserved.

**50 Hz**

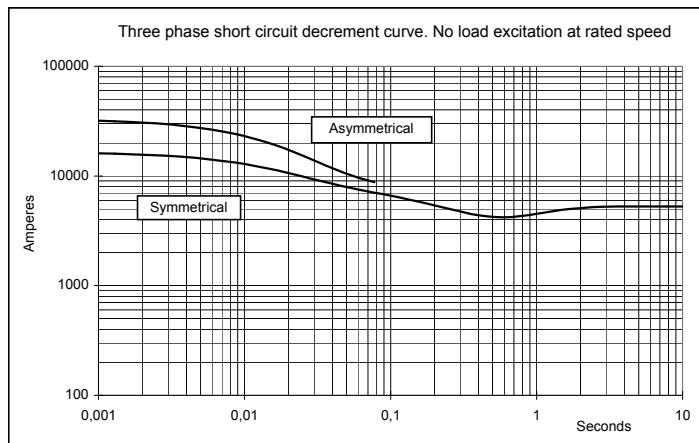
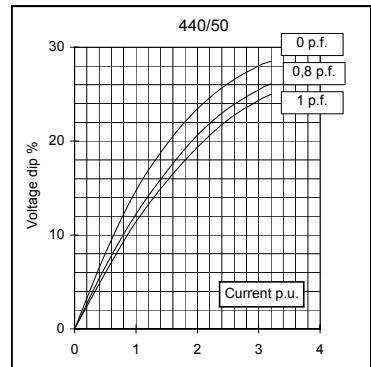
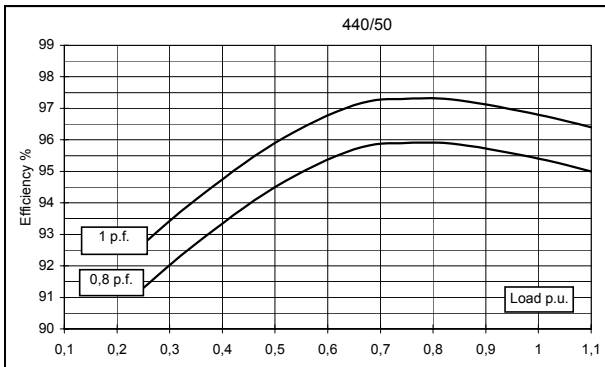
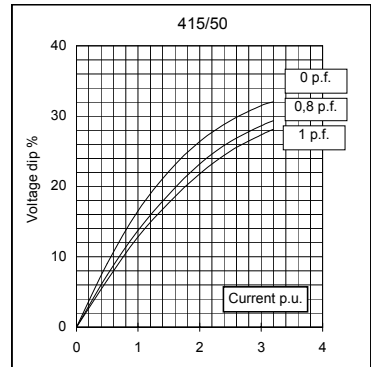
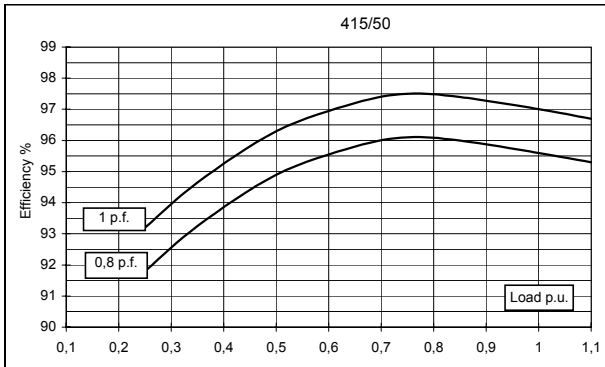
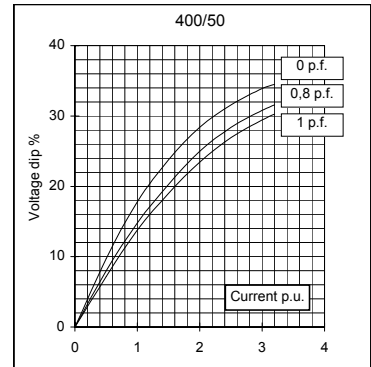
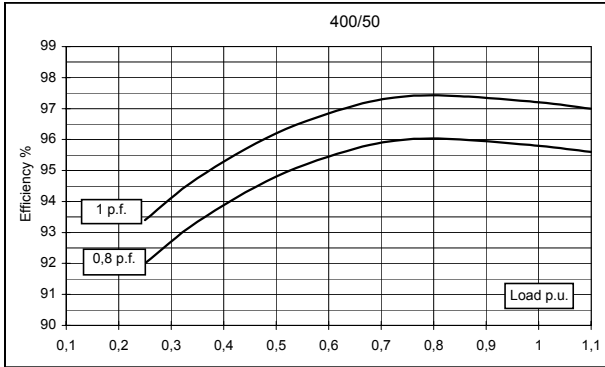
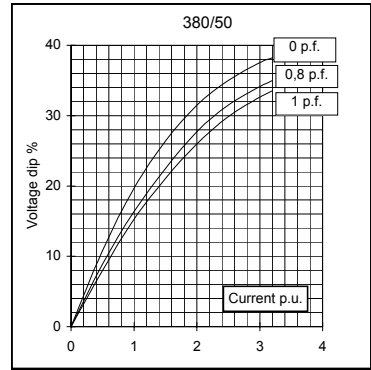
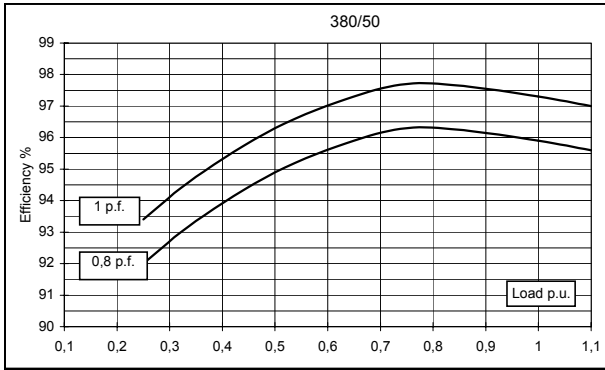

**60 Hz**

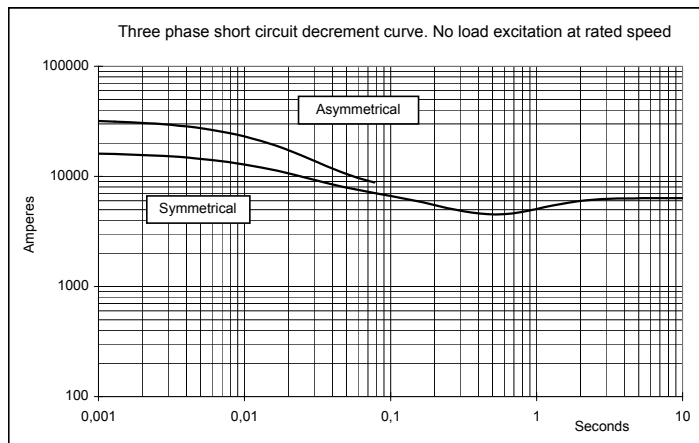
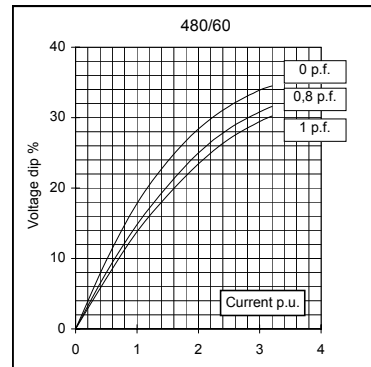
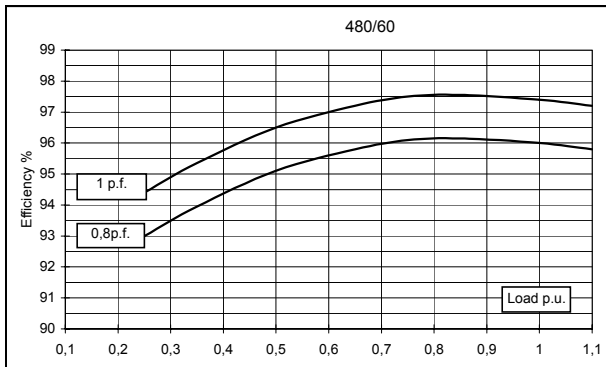
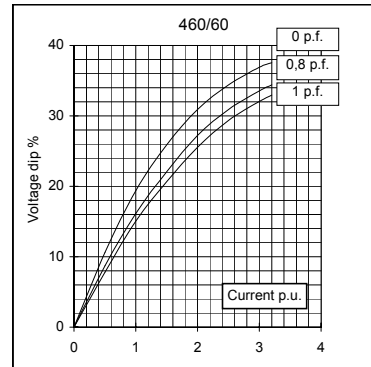
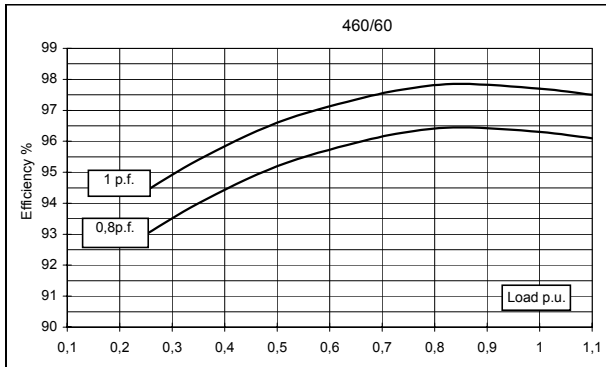
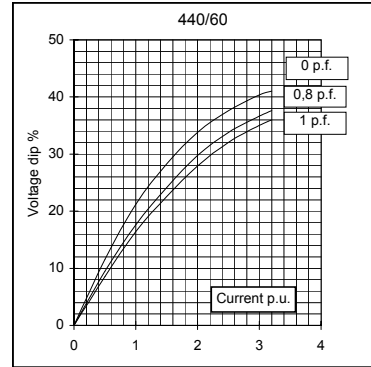
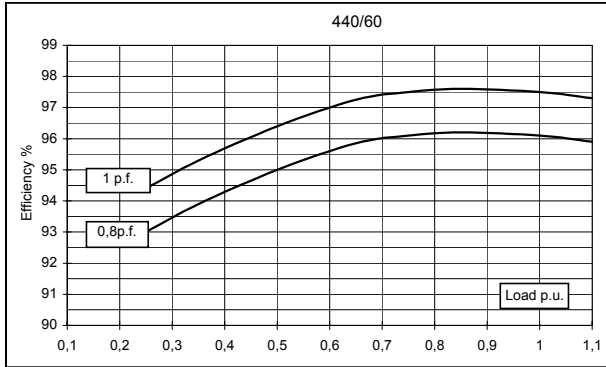
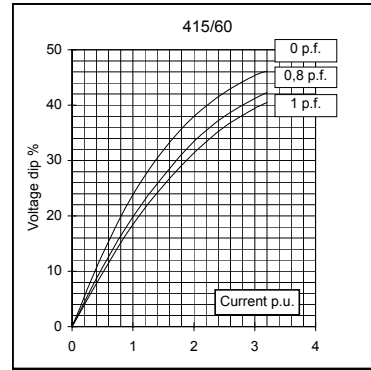
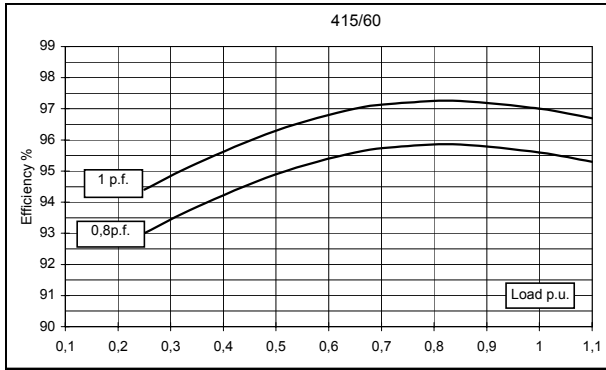

### TWO BEARING MOMENTS OF INERTIA

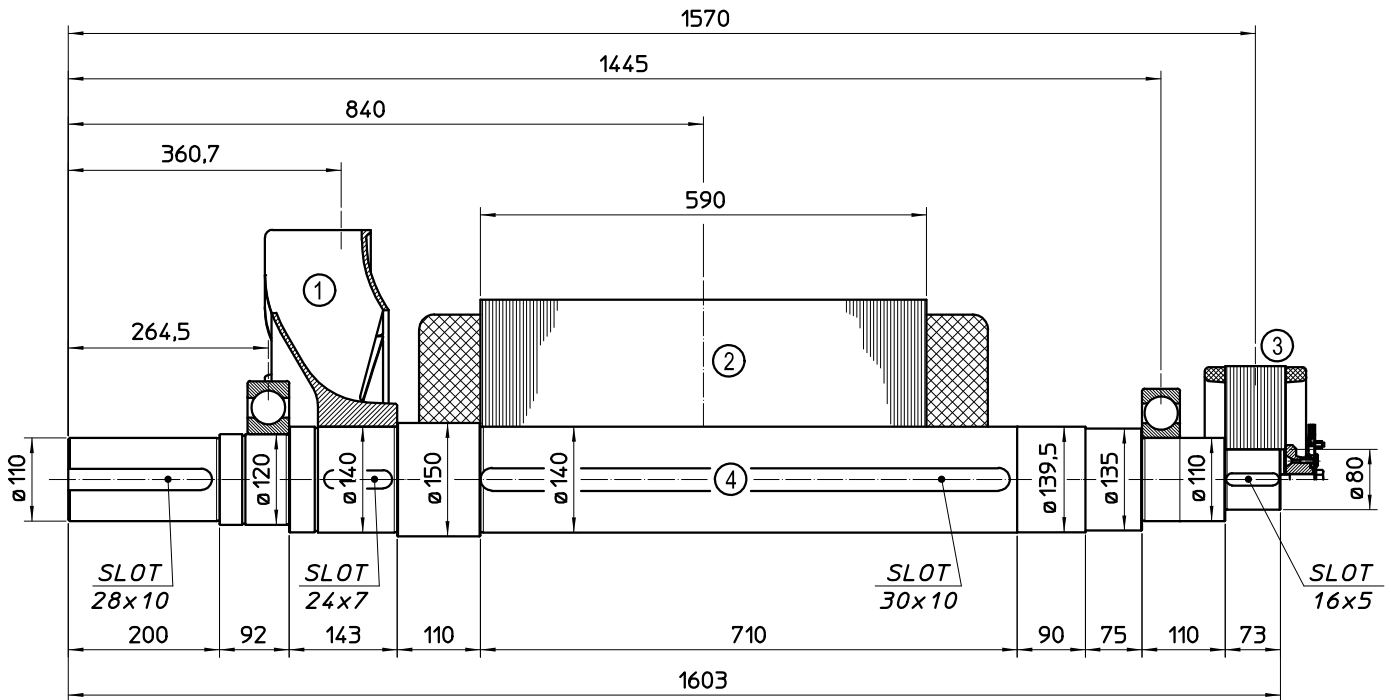

POS.	COMPONENT	WEIGHT (kg)	J (kgm <sup>2</sup> )
1	FAN	16.3	0.646
2	MAIN ROTOR	642	19.761
3	EX. ROTOR	40	0.629
4	SHAFT	171.3	0.485
TOTAL		869.6	21.521

### TWO BEARING DIMENSIONS

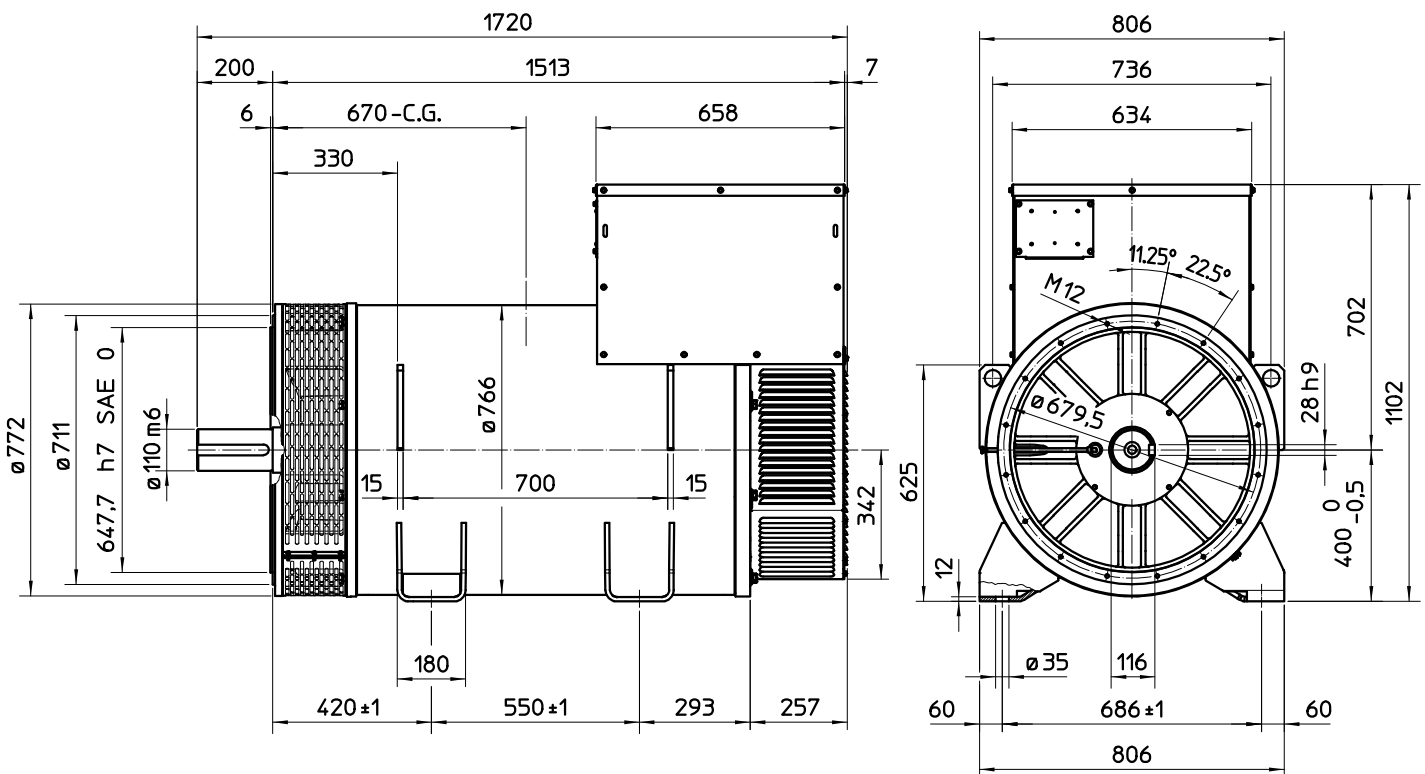

C.G.= GRAVITY CENTER

### SINGLE BEARING MOMENTS OF INERTIA

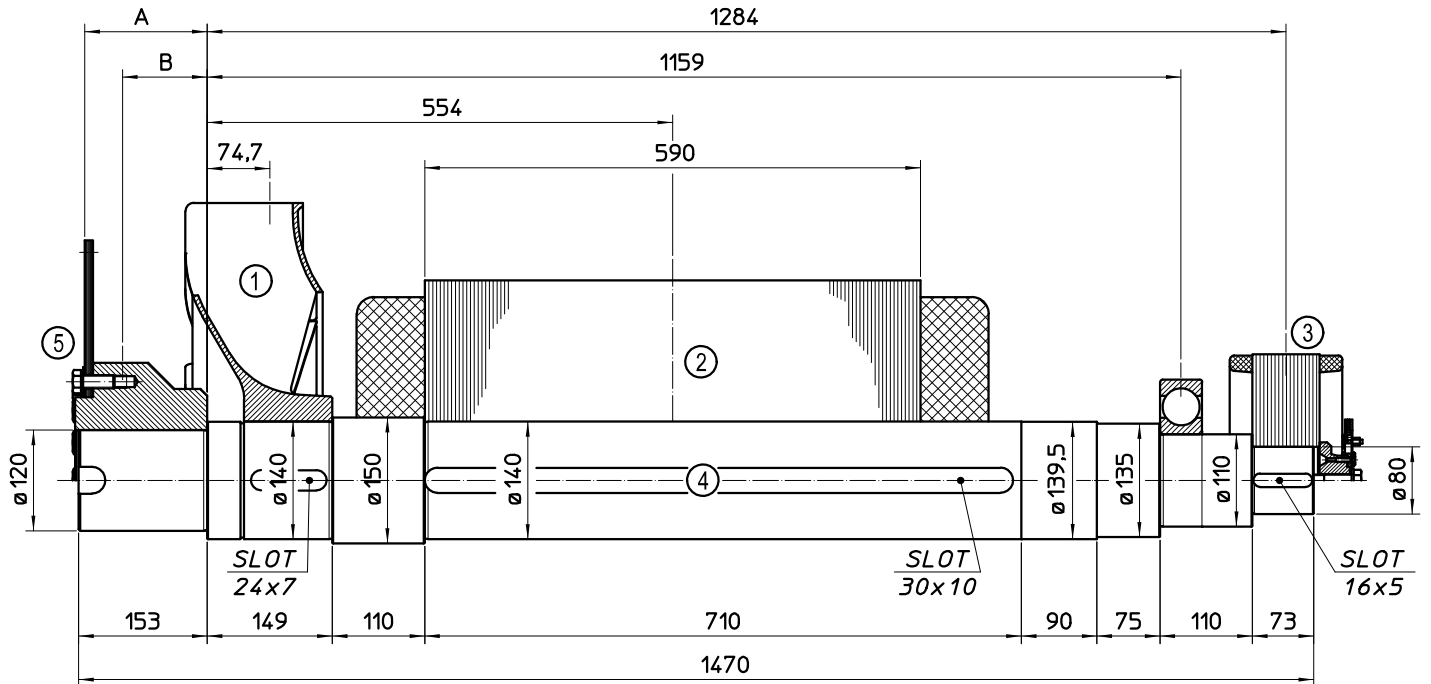

POS.	COMPONENT	WEIGHT (kg)	J (kgm <sup>2</sup> )
1	FAN	16.3	0.646
2	MAIN ROTOR	642	19.761
3	EX. ROTOR	40	0.629
4	SHAFT	159.6	0.371
TOTAL		857.9	21.407

POS.	COMPONENT	SAE N°	A	B	WEIGHT (kg)	J (kgm <sup>2</sup> )
5	SHAFTS COUPLING FLEX PLATE	14	155.7	99.5	56.3	0.824
		18	145.7	100.7	60.8	1.244
		21	130	98.5	68.9	2.231

### SINGLE BEARING DIMENSIONS

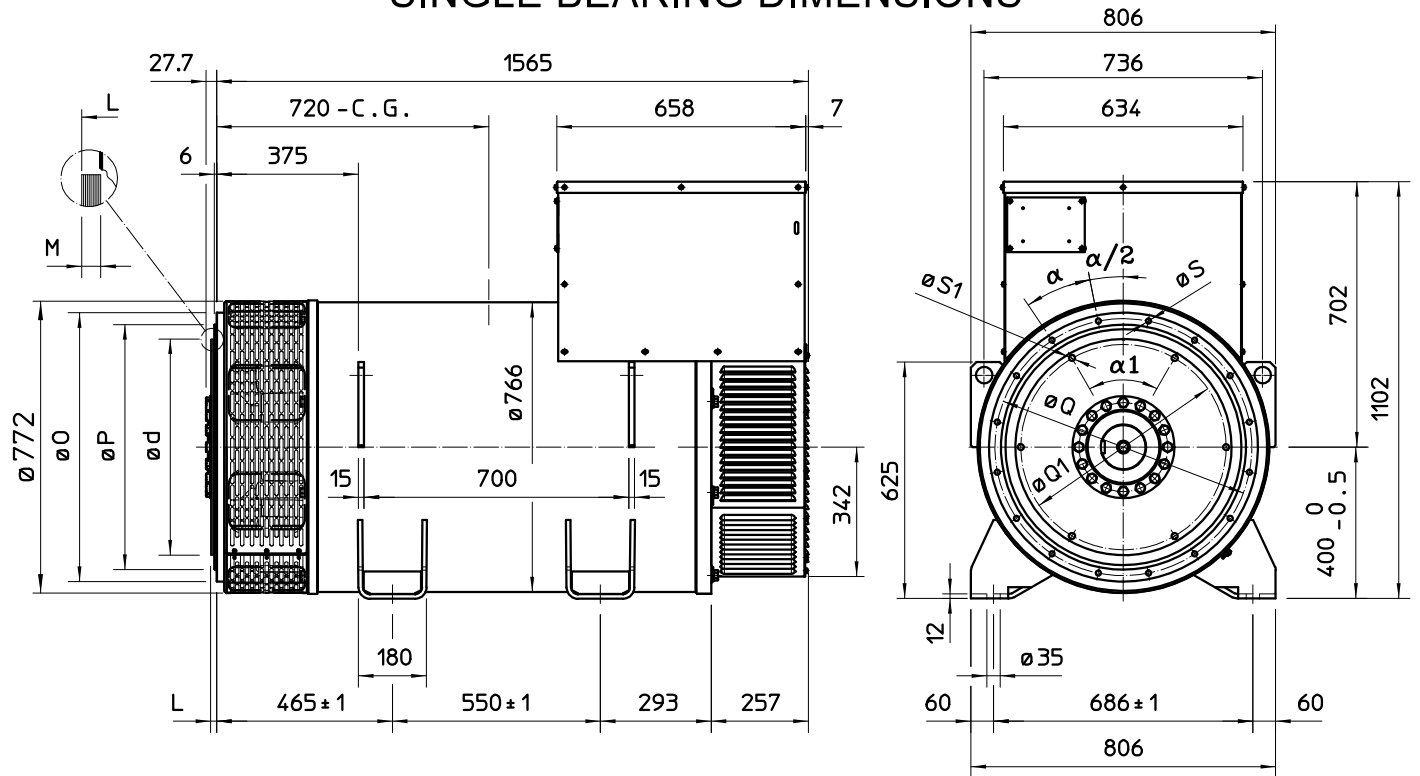

SAE N°	FLANGE					
	O	P	Q	S	HOLES N°	$\alpha$
1	711	511.2	530.2	12	12	30
0	711	647.7	679.5	14	16	22.5
00	883	787.4	850.9	14	16	22.5

SAE N°	DISC COUPLING						
	d	L	M	Q1	S1	HOLES N°	$\alpha 1$
14	466.72	25.4	10	438.15	13.5	8	45
18	571.5	15.7	10	542.92	16.5	6	60°
21	673.1	0	12	641.35	16.5	12	30°

C.G.= GRAVITY CENTER