



GENERATOR TYPE ECO 46-1S/4

Document : **DS060A/1**

issue 004 date 01/04/2014

Electrical Characteristics										
Frequency	Hz	50				60				
Voltage (parallel star)	V	380	400	415	440	415	440	460	480	
Rated power class H	kVA	1500	1500	1500	1300	1600	1710	1800	1800	
	kW	1200	1200	1200	1040	1280	1368	1440	1440	
Rated power class F	kVA	1350	1350	1350	1170	1440	1530	1620	1620	
	kW	1080	1080	1080	936	1152	1224	1296	1296	
Regulation with	DER1	±1% with any power factor and speed variations between -5% +30%								
Insulation class		H								
Execution		Brushless								
Stator winding		12 ends								
Rotor		with damping cage								
Efficiencies class H	4/4	%	96,3	96,2	96	95,8	96,1	96,3	96,5	96,4
(see graph. for details)	3/4	%	96,7	96,4	96,5	96	96,2	96,5	96,9	96,6
	2/4	%	96	95,9	95,9	95,5	95,6	96	96,2	96,1
	1/4	%	95,3	95,3	95,1	94,6	94,8	95,2	95,3	95,4
Reactances (f. l.cl. F)	Xd	%	291,4	263	244,3	202	315	295,6	286,4	263
	Xd'	%	28,3	25,5	23,7	19,8	29,7	28,66	27,8	25,5
	Xd''	%	14,3	12,9	12,0	10,1	15,8	14,50	14,0	12,9
	Xq	%	186,1	168	156,1	125	197	188,8	182,9	168
	Xq'	%	186,1	168	156,1	125	197	188,8	182,9	168
	Xq''	%	31,2	28,2	26	21,8	33,2	31,7	30,7	28,2
	X ₂	%	20,5	18,5	17,2	14,5	22,1	20,79	20,1	18,5
	X ₀	%	4,5	4,1	4	3,6	4,7	4,61	4,5	4,1
Short Circuit Ratio	Kcc		0,34	0,38	0,41	0,48	0,31	0,34	0,35	0,38
Time Constants	Td'	sec.	0,250							
	Td''	sec.	0,021							
	Tdo'	sec.	9,50							
	Tα	sec.	0,027							
Short Circuit Current Capacity		%	>300				>350			
Excitation at no load	Amp.		0,6	0,7	0,8	0,95	0,4	0,5	0,6	0,65
Excitation at full load	Amp.		2,8	2,9	3	3,1	2,8	2,7	2,75	2,8
Overload (long-term)	%	1 hour in a 6 hours period 110% rated load								
Overload per 20 sec.	%	300								
Stator Winding Resistance (20°C)	Ω	0,0057								
Rotor Winding Resistance (20°C)	Ω	3,050								
Exciter Resistance (20 °C)	Ω	Rotor : 0,120				Stator : 12,90				
Heat dissipation at f.l.cl.H	W	46106	47401	50000	45595	51946	52561	52228	53776	
Telephone Interference		THF < 2%				TIF < 40				
Radio interference		EN61000-6-3, EN61000-6-2. For others standards apply to factory								
Waveform Distors.(THD) at f. load	LL/LN %	3 / 2,9								
Waveform Distors.(THD) at no load	LL/LN %	2,5 / 2,4								
Mechanical characteristics										
Protection		IP 21 (other protection on request)								
DE bearing		6330								
NDE bearing		6324								
Weight of wound stator assembly	kg	1080								
Weight of wound rotor assembly	kg	705								
Weight of complete generator	kg	3010								
Maximun overspeed	rpm	2250								
Unbalanced magnetic pull at f.l.cl.F	kN/mm	6,4								
Cooling air requirement	m³/min	135				162				
Inertia Constant (H)	sec.	0,326				0,391				
Noise level at 1m/7m	dB(A)	97 / 86				100 / 91				

All technical data are to be considered as a reference and they can be modified without any notice.

This document is a propriety of Mecc Alte S.p.A.. All rights reserved.

50 Hz

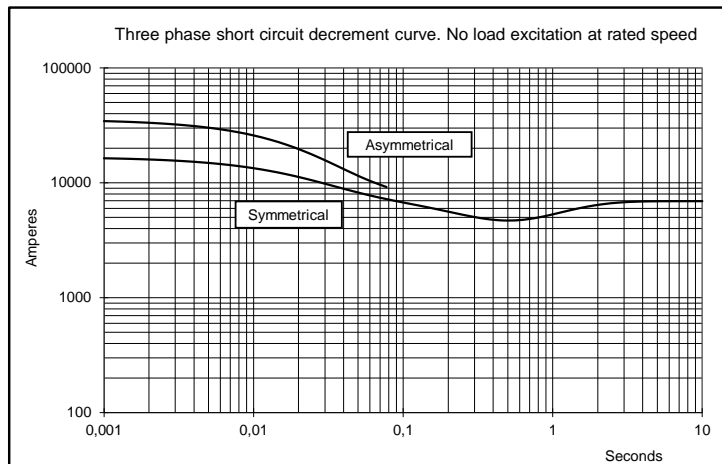
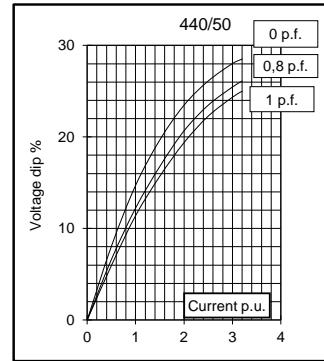
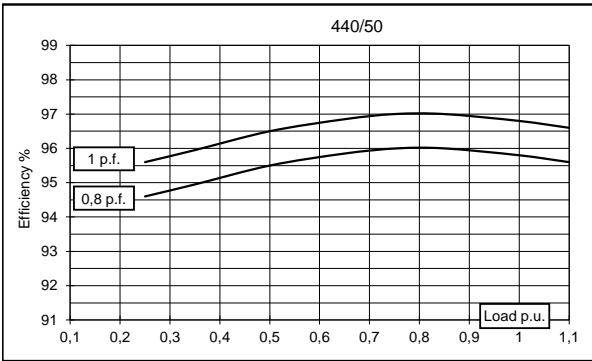
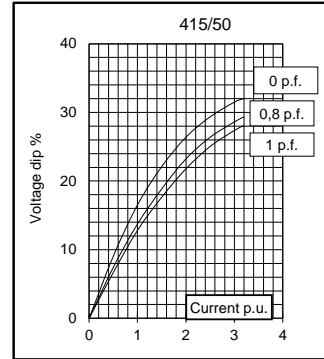
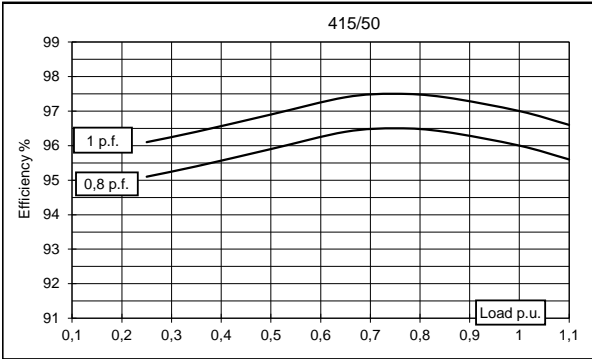
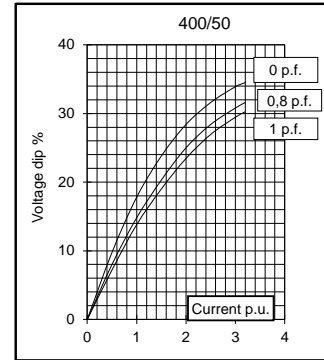
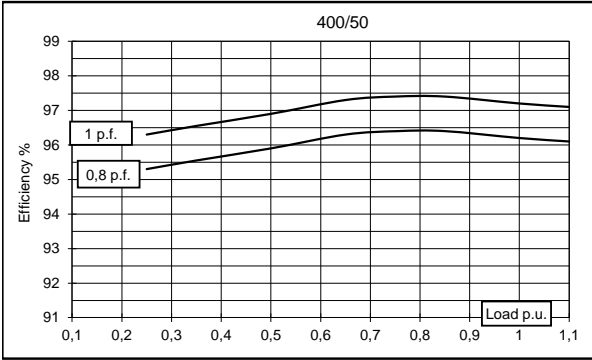
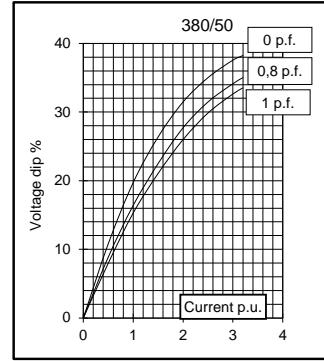
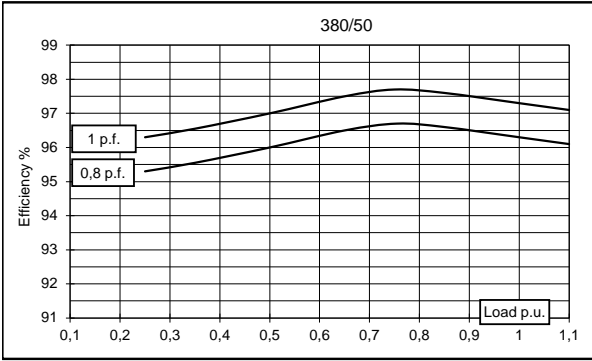

60 Hz

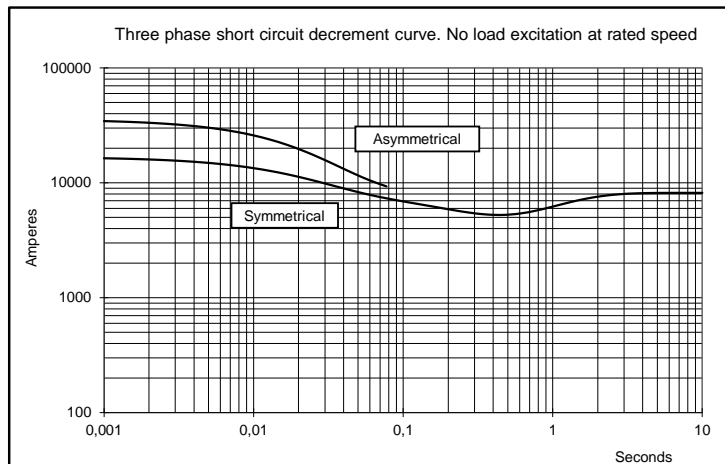
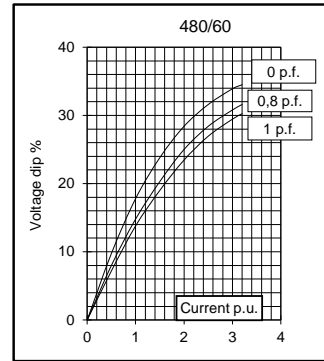
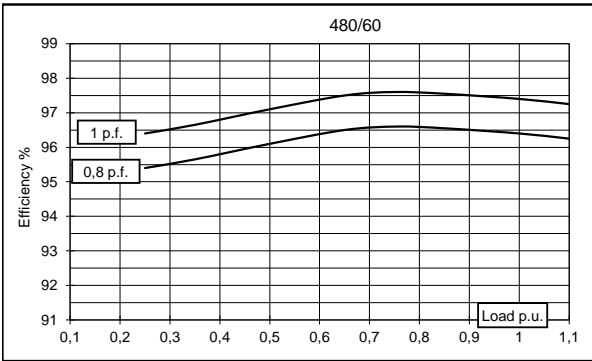
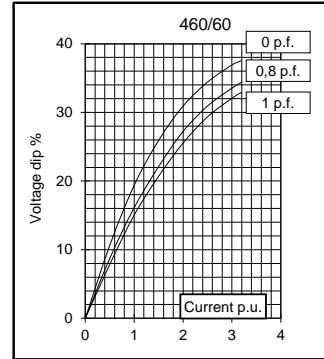
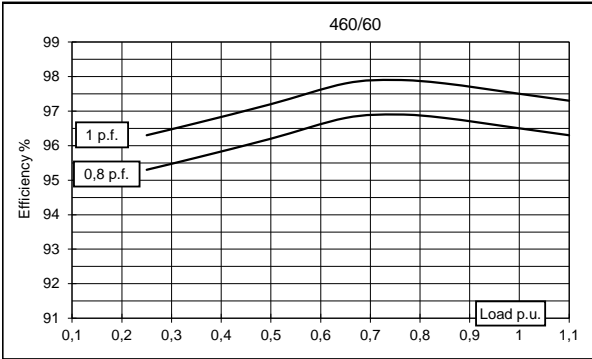
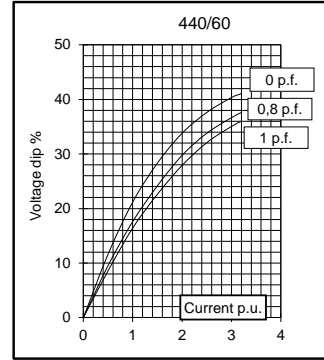
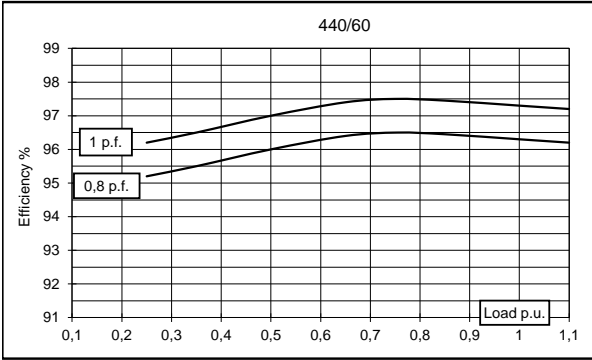
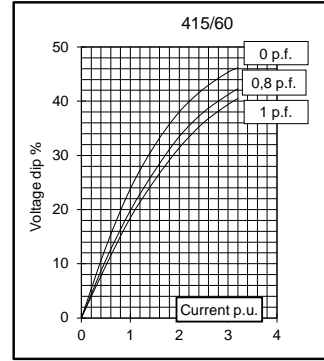
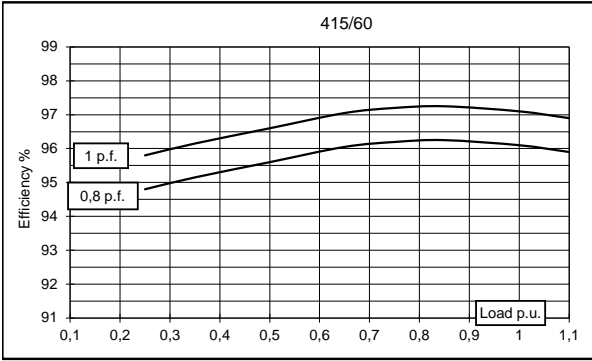

TWO BEARING MOMENTS OF INERTIA

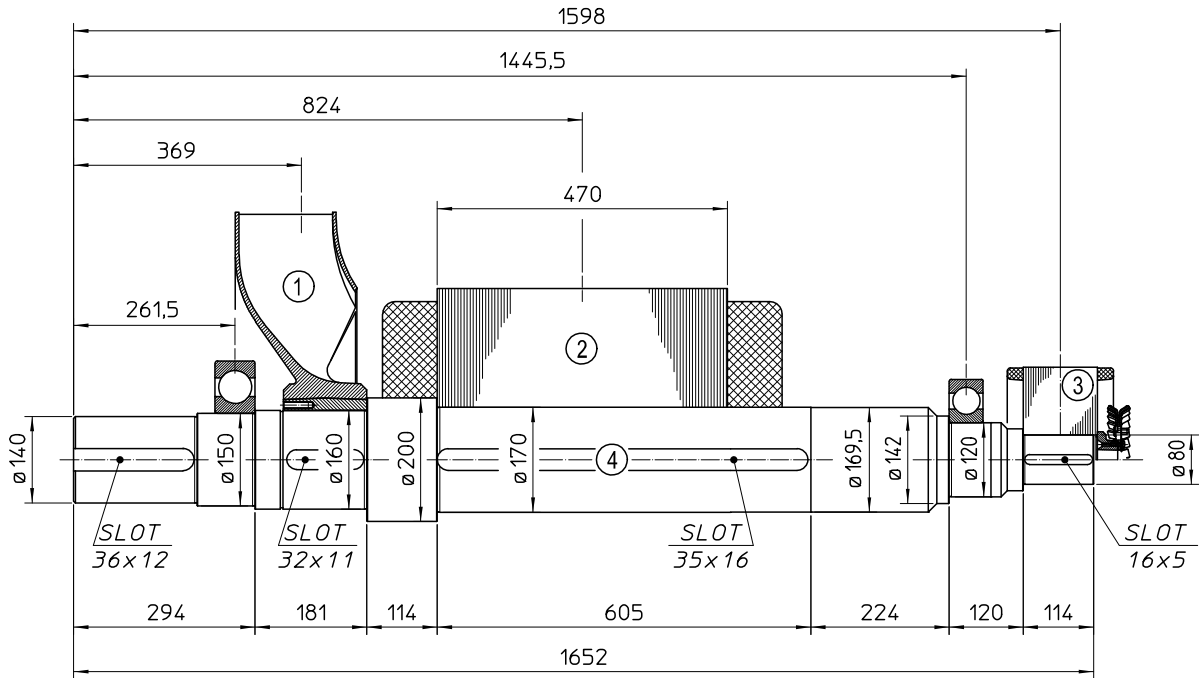

POS.	COMPONENT	WEIGHT (kg)	J (kgm ²)
1	FAN	42.7	2,250
2	MAIN ROTOR	705	27.608
3	EX. ROTOR	60	0,730
4	SHAFT	248.3	0,844
TOTAL		1056	31.432

TWO BEARING DIMENSIONS

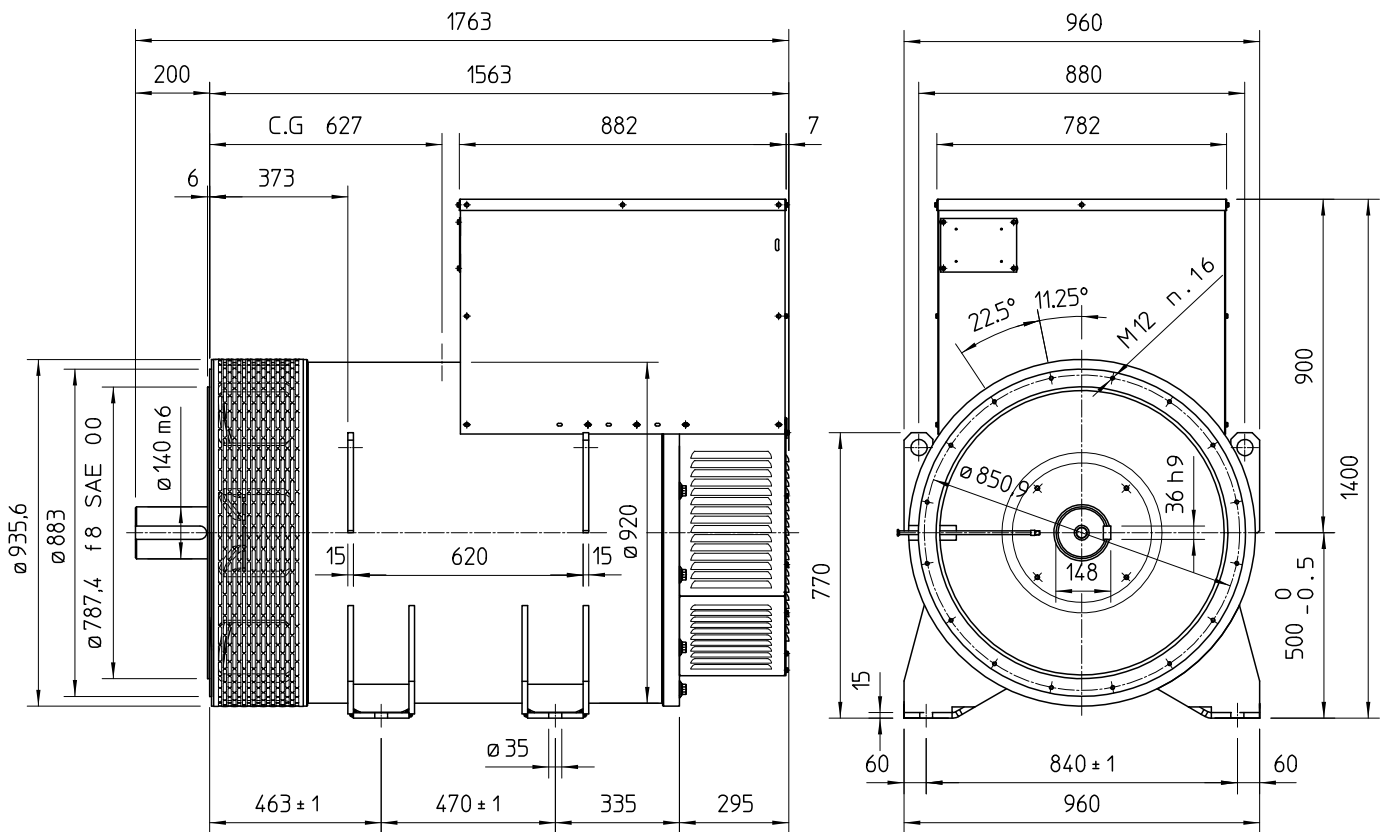

C.G.= GRAVITY CENTER

SINGLE BEARING MOMENTS OF INERTIA

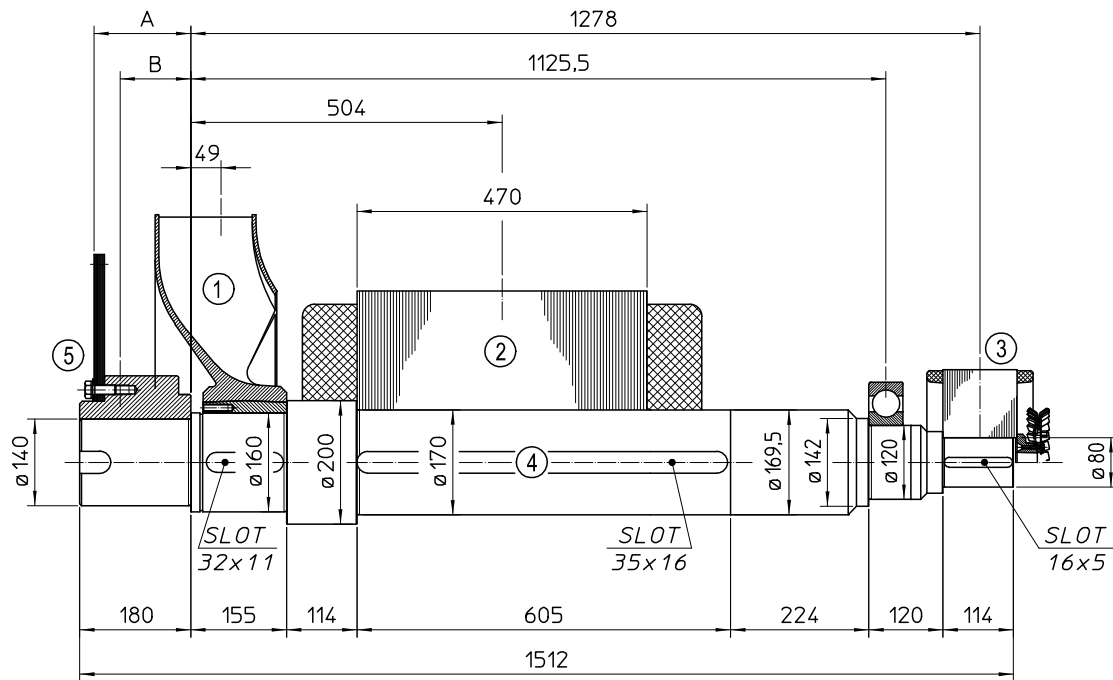

POS.	COMPONENT	WEIGHT (kg)	J (kgm ²)
1	FAN	42.7	2,250
2	MAIN ROTOR	705	27.608
3	EX. ROTOR	60	0,730
4	SHAFT	230	0,792
TOTAL		1037.7	31.38

SAE N°	5		SHAFTS COUPLING FLEX PLATE	
	A	B	WEIGHT kg	J kgm ²
18	172.7	113.4	82.7	1.863
21	157	114.6	93.6	3.206

SINGLE BEARING DIMENSIONS

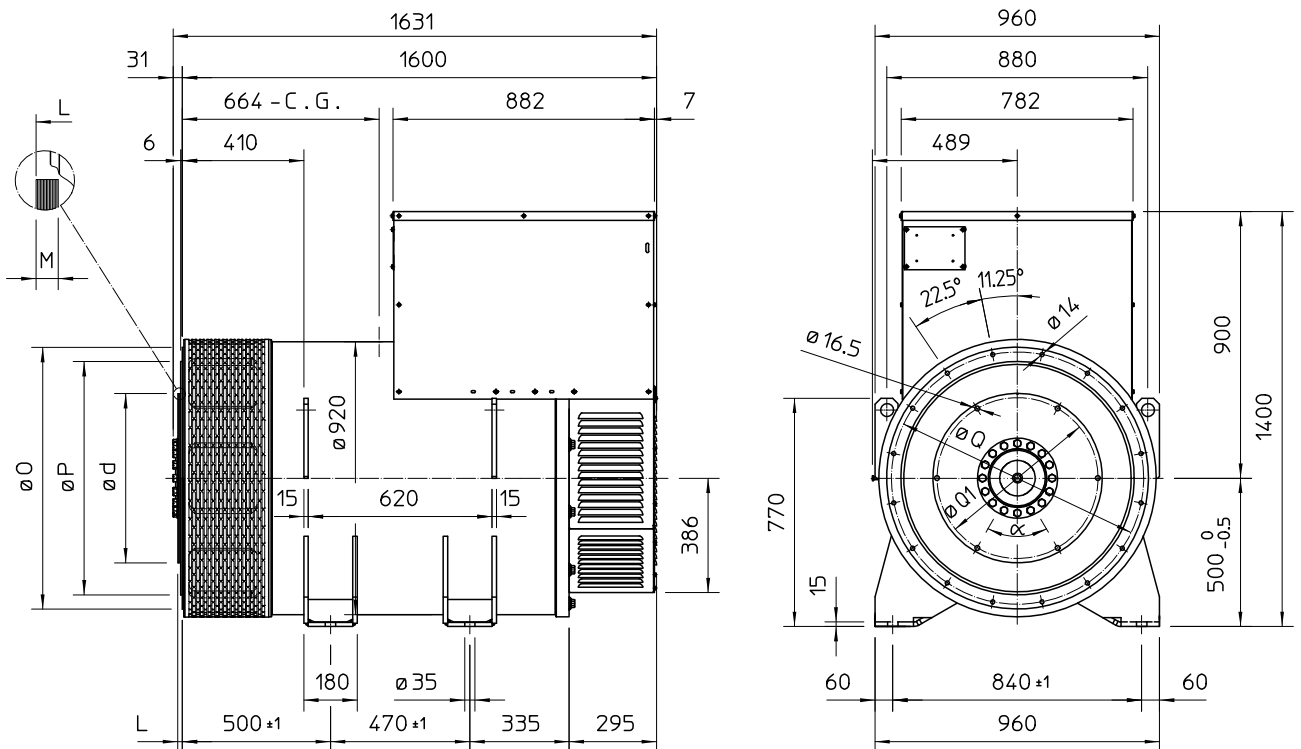

SAE N°	FLANGE		
	O	P	Q
0	711	647.7	679.5
00	883	787.4	850.9

SAE N°	DISC COUPLING						
	d	L	M	Q1	HOLES N°	α	
18	571.5	15.7	15	542.92	6	60°	
21	673.1	0	17	641.35	12	30°	

C.G.= GRAVITY CENTER